

E13-2000-128

I.E.Chirikov-Zorin, I.Fedorko¹, A.Menzione², I.Sykora¹,
S.Tokar¹

PRECISE ANALYSIS
OF THE METAL PACKAGE PHOTOMULTIPLIER
SINGLE PHOTOELECTRON SPECTRA

Presented at the 8th Pisa Meeting
on Advanced Detectors «Frontier Detectors for Frontier Physics»,
May 21–27, 2000, La Biodola, Isola d'Elba, Italy

¹Comenius University, Bratislava, Slovak Republic

²Istituto Nazionale di Fisica Nucleare, Pisa, Italy

1 Introduction

Analysis of the PMT pulse height spectra from faint light sources (usually called the single photoelectron spectra) is of a great importance because it reveals many features and can be used to find relevant parameters of PMTs. The single photoelectron analysis ([1-3]) can be used for:

- calibration and monitoring of the PMT-based spectrometric channels.
- finding of the PMT noise characteristics, especially so called excess factor (see below).

2 Photomultiplier Response Function

The PMT response function presented in this paper was built up under the same principles as the one in our previous work [4], but some modifications have been done to enable employment of the method for the low gain ($\sim 10^5$) applications. The output charge spectrum is a sum of all possible convolutions corresponding to the charge multiplication processes initiated by n photoelectrons from photocathode and k ones from first dynode:

$$S_{real}(x) = \sum_{n,k=0}^{\infty} \frac{\mu_{pc}^n e^{-\mu_{pc}}}{n!} \cdot \frac{\mu_1^k e^{-\mu_1}}{k!} \cdot \int dx' S_n^{(1)}(x') \cdot S_k^{(2)}(x - x') \quad (1)$$

where μ_{pc} is the number of photoelectrons created on the photocathode and captured by the PMT dynode system, μ_1 is the number of photoelectrons created on the first dynode and captured by the following part of the dynode system and $S_n^{(1)}(x)$ ($S_k^{(2)}(x)$) is the PMT output charge when the multiplication process is initiated by n photoelectrons from photocathode (k photoelectrons from first dynode).

The Poisson factors in (1), standing before the convolution of the responses $S_n^{(1)}$ and $S_k^{(2)}$, express the probability that the charge multiplication process was initiated by n photoelectrons from photocathode and k ones from first dynode. A modification of the previously presented response function was evoked by a need to employ the metal package PMTs at low gains [7]. At low gains the charge output distribution is asymmetric if the multiplication process is initiated by three or less photoelectrons. This fact is supported by simulation (see part3). The low photoelectron boundary for the present response function is set to 3 while in the previous one it was 2:

$$S_n^{(1)}(x) = \begin{cases} \sum_{m=0}^{\infty} \frac{K_1^m \cdot e^{-K_1}}{m!} \cdot S_m^{(2)}(x) & n = 1 \\ \sum_{m=0}^{\infty} K_1^m e^{-2K_1} \cdot S_m^{(2)}(x) \cdot \sum_{l=0}^n \frac{1}{(m-l)!!!} & n = 2 \\ \sum_{m=0}^{\infty} K_1^m e^{-3K_1} \cdot S_m^{(2)}(x) \cdot \sum_{l=0}^m \frac{1}{l!} \sum_{k=0}^{m-l} \frac{1}{k!(m-l-k)!!!} & n = 3 \\ G(x, Q_0 + nQ_1, \sigma_0^2 + n\sigma_1^2) & n = 0, n \geq 4 \end{cases} \quad (2)$$

where, Q_0, σ_0 are the pedestal and its width; Q_1, σ_1 are the mean output charge initiated by one photoelectron and one photoelectron response standard deviation; K_1 is the secondary emission coefficient of the first dynode; $S_m^{(2)}(x)$ is the PMT response for the multiplication process started by an electron from the first dynode; $G(x, Q, \sigma^2)$ is a Gaussian distribution with the mean value of Q and dispersion σ^2 : μ_{pc} - from the photocathode and μ_1 - from the first dynode.

For the response, when photoelectrons are created on first dynode, an expression analogous to (2) can be written. However, in this case (like before [4]) the expansion through Poisson factors is done only if the charge multiplication is initiated by one electron from the first dynode.

2.1 Limit Spectrum

As was shown in our previous works [2,4] at large values of μ_{pc} the Poisson distribution in (1) becomes Gaussian and the PMT response function goes to a limit spectrum:

$$S_{real}(x) \xrightarrow{\mu_{pc} \rightarrow \infty} S_{\infty}(x) = \frac{1}{\sqrt{2\pi}\sigma_{\infty}} \exp\left(-\frac{(x - Q_0 - Q_{\infty})^2}{2\sigma_{\infty}^2}\right) \quad (3)$$

where

$$Q_\infty = \mu_{pc}Q_1 + \mu_1Q_2 = \mu_{pc}Q_1 \left(1 + \frac{\epsilon}{K_1}\right) \quad (4)$$

$$\sigma_\infty = \sqrt{\sigma_0^2 + \mu_{pc}(\sigma_1^2 + Q_1^2) + \mu_1(\sigma_2^2 + Q_2^2)} \quad \epsilon < 0.1 \quad \sqrt{\mu_{pc}(\sigma_1^2 + Q_1^2)} \quad (5)$$

where $\epsilon = \mu_1/\mu_{pc}$ and K_1 is the secondary emission coefficient on first dynode.

From (4) and (5) a relation between the limit spectrum parameters (Q_∞ , σ_∞) and the mean number of photoelectrons (μ_{pc} , μ_1) can be found:

$$\mu_{pc} = f_{pmt} \cdot \frac{Q_\infty^2}{\sigma_\infty^2} \quad (6)$$

$$f_{pmt} = \frac{\sigma_1^2 + \epsilon\sigma_2^2 + Q_1^2 \left(1 + \frac{\epsilon}{K_1^2}\right)}{Q_1^2 \left(1 + \frac{\epsilon}{K_1}\right)^2} \rightarrow 1 + \frac{\sigma_1^2}{Q_1^2} \quad (7)$$

The factor f_{pmt} , usually called the excess factor, depends on the single photoelectron parameters of the PMT in question, and reflects a quality of the PMT. The second term in (7) is a contribution of the fluctuations caused by dynode system. It is desirable to have the contribution of dynode system to PMT output charge fluctuations as low as possible. In an ideal case, when the charge multiplication process is supposed to obey Poisson law, the dynode system charge fluctuations can be determined theoretically. In this case for the variance σ_1^2 [4,9] we have:

$$\sigma_1^2 = Q_1^2 \left(\frac{1}{k_1} + \frac{1}{k_1 k_2} \dots + \frac{1}{k_1 \dots k_N} \right) \quad (8)$$

where k_i are the dynode secondary emission coefficients. These coefficients are determined by interdynode voltages [10] and can be inferred from the measured gain dependence on voltage [4]. Using the dependence of secondary emission coefficients on voltage the PMT gain (G) can be express as follows:

$$G = \prod_{i=1}^N k_i, \quad k_i = \gamma \left(\frac{r_i}{\sum_{j=1}^{N+1} r_j} U \right)^\alpha \quad (9)$$

where U is the voltage between photocathode and anode, γ is a coefficient determining the absolute gain of the PMT, r_i ($i = 1, \dots, N+1$) are the voltage divider ratios, N is the number of dynodes and α is a material dependent coefficient.

Comparing the theoretical prediction for the ideal case (8) with the experimental one, determined by the single photoelectron analysis, one can make a conclusion about the presence of inhomogeneities in the charge multiplication process.

3 The Results of Analysis

The experimental pulse height spectra were analysed by means of the response function (1), for the eight dynode R5600 and R5900 Hamamatsu photomultipliers. The results of the tests of the new PMT response function as well as the results on the excess factor analysis are summarised below.

3.1 The Experimental Setup

Our analytical method based on the deconvolution of the LED spectra using the response function (1) was tested on the experimental data. The block diagram of the experimental setup is shown in Fig. 1. The fast AlGaAs LED HLMP8100 ("Hewlett Packard") was used as a pulsed light source. The LED was driven by a pulse generator (GEN) with a short pulse width (≈ 5 ns). An optical fiber was used to transmit light from the LED to the PMT. The photon flux incident on the photocathode was tuned by changing the supply voltage to the LED. The analog signal from the PMT was amplified by a preamplifier and measured by an ADC (LeCroy 2249A). The width of the gate signal was 120 ns and the generator sampling frequency was 1 kHz. The output information from the ADC was read by means of a PC computer.

3.2 Comparison of the experimental spectra with the simulation.

We simulated an 8-staged PMT assuming the charge multiplication process is an ideal one, i.e. production of secondaries obeys Poisson law, no inhomogeneities are present, photoelectrons are created only on photocathode and collection efficiency of dynode system is 100%. We carried out the simulation for the gain 10^5 with the aim to find out how the form of PMT response depends on number of photoelectrons initiating it. The details of the simulation code were published elsewhere [8]. The results are presented in Fig. 2, where the charge distributions initiated by $n = 1, 2, 3$ and 4 photoelectrons are shown. We can conclude that for the gains below 10^5 the "idealised" PMT response exhibits a noticeable asymmetry also in the case of 3 photoelectrons and symmetric (Gaussian) approximation of charge distribution components is appropriate only for 4 or more photoelectrons. One can expect that inhomogeneities (in a real case) will not change this fact dramatically, i.e. our choice to expand the PMT response, in cases when it is initiated by 3 or less photoelectrons, is justified. In the simulation we assumed an 8 dynode stages PMT with the divider ratio $1 : 1 : \dots : 1 : 1$ and the gain 10^5 .

3.3 Analysis of the experimental spectra

The new PMT response function has been used for analysis of the spectra taken by the Hamamatsu R5600 and R5900 PMTs. An examples of the single photoelectron spectra for the R5600 phototube taken at the voltages of 700 V and 850 V are shown in Fig. 3. The

spectra taken by the R5900/9D16C2 phototube at different voltages (700 V and 900 V) are shown in Fig.4. In all cases a good description of the experimental spectra by the suggested response function can be stated. In the R5600 case a significant first dynode effect is seen and properly treated by the presented method.

We applied the suggested response function on study of the R5900/9D16C02 PMT for the need of ATLAS/TILECAL collaboration. In Figs.5a is shown the dependence of the PMT gain (parameter Q_1 , see part 2) on voltage. The dependence of the excess factor f_{PMT} , defined by (7), on voltage is shown in Fig.5b. It is interesting to compare the experimentally obtained values of f_{PMT} with the theoretical ones calculated using (8), where an ideal charge multiplication process is assumed. From the comparison in Tab. 1 we see that the experimental values of f_{PMT} are not far from those of the ideal process. The results of the time stability tests of the method are shown in Fig.6 where dependence of gain and excess factor are depicted for the spectra taken during an 80 hours interval. We have also investigated the systematics of the method taking the spectra at 712 V (nominal voltage) with different light source intensity ranging from 0.8 to 6.5 photoelectrons. The results are presented in Fig. 7 where the gains and noise factors are shown as a function of input light signal. From the figures we see that in the whole range the method is stable in frame of 2%. If we restrict the light input signal to the region from 1.5 to 5 photoelectrons the f_{PMT} values differ each other in less than 1%.

Table 1: Dependence of the excess factor on voltage (U) found experimentally by the single photoelectron analysis (f_{PMT}^{ex}) and calculated for the ideal process (f_{PMT}^{th}) using (8).

U [V]	600	650	700	750	800	850	900	950
f_{PMT}^{ex}	1.311	1.274	1.260	1.242	1.235	1.225	1.217	1.214
	± 0.022	± 0.017	± 0.019	± 0.016	± 0.014	± 0.022	± 0.007	± 0.006
f_{PMT}^{th}	1.283	1.260	1.241	1.225	1.210	1.198	1.188	1.178

4 Conclusions

The presented results show that the proposed method for analysis of single photoelectron spectra, works well, at least for the class of the metal package photomultipliers.

The PMT response function used in this method enables to reveal very subtle effects as the photoconversion on first dynode and/or direct capture of photoelectrons by second dynode.

The method uses only the elementary physical principles and therefore can be easily adapted to other types of photomultipliers.

The method can be used as a tool for studying of PMT charge fluctuations - it enables to find out experimentally the PMT access factor needed for calculation of the energy-to-signal conversion factor (number of photoelectrons per GeV) for the PMT based calorimeters.

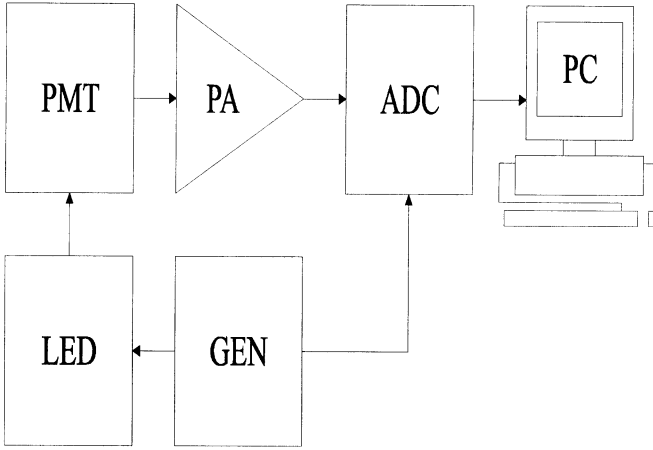

Fig. 1. Block scheme of the experimental setup for the measurement of single photoelectron spectra.

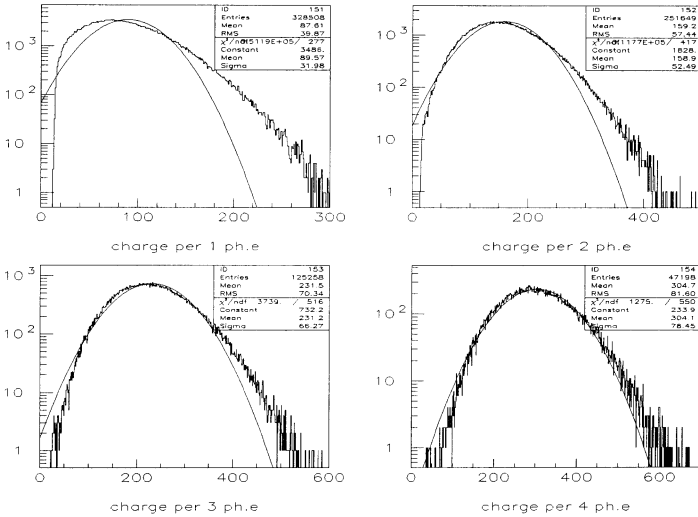

Fig. 2. The simulated PMT response initiated by different number of photoelectrons $n = 1, 2, 3$ and 4 , at the gain of 10^5 .

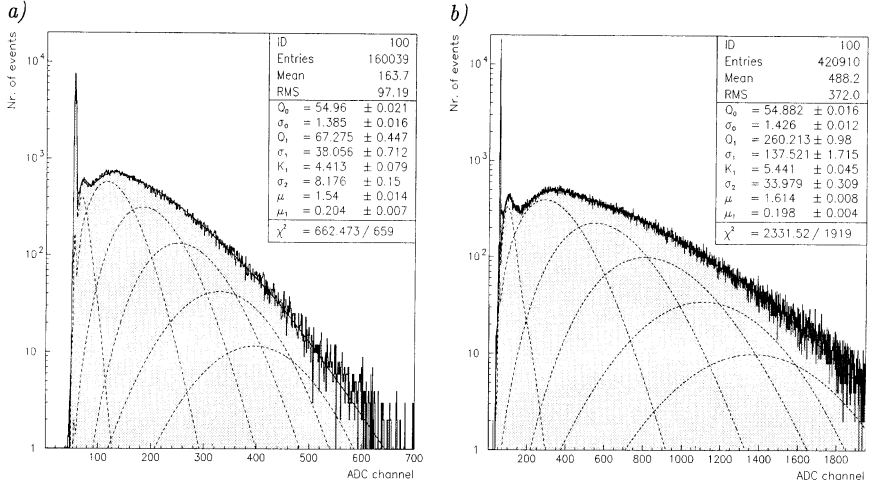

Fig. 3. The analysed LED spectrum taken at 700 V (a) and 850 V (b) by the R5600 phototube.

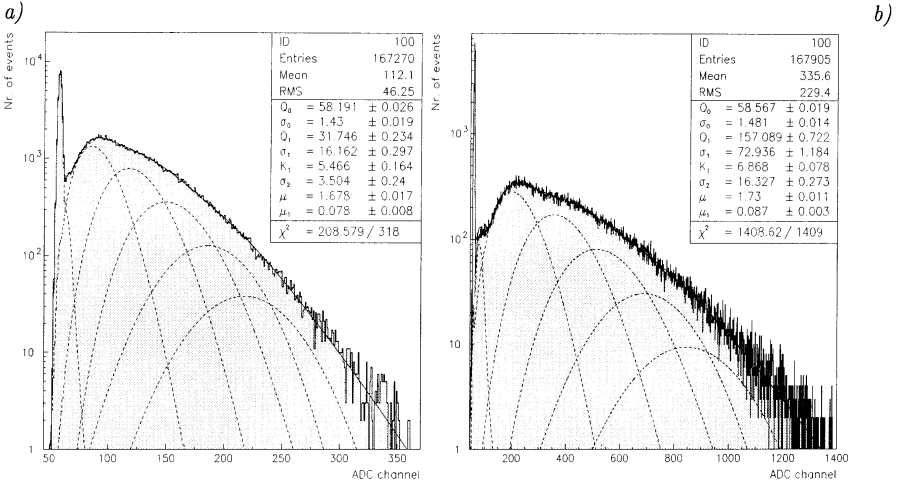

Fig. 4. The deconvoluted LED spectrum taken at 700 V (a) and 900 V (b) by the Hamamatsu R5900/9D16C2 photomultiplier.

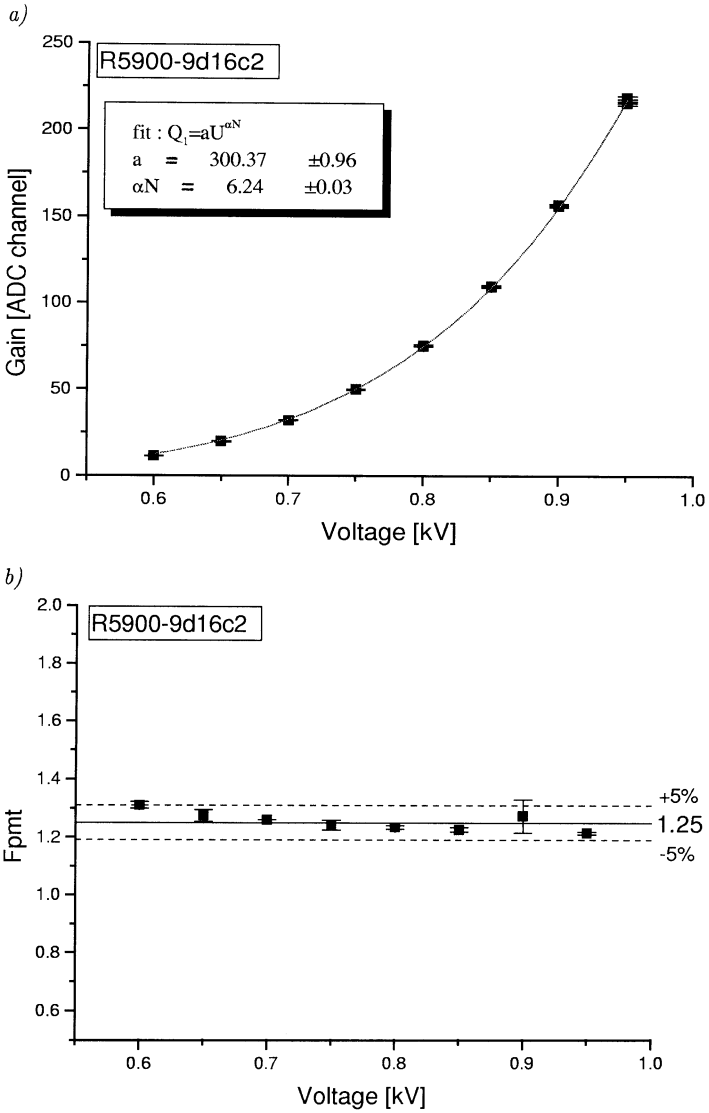

Fig. 5. The PMT R5900/9d16c2 characteristics: *a*) dependence of the PMT gain (Q_1) on voltage (kV), *b*) dependence of the excess factor on voltage.

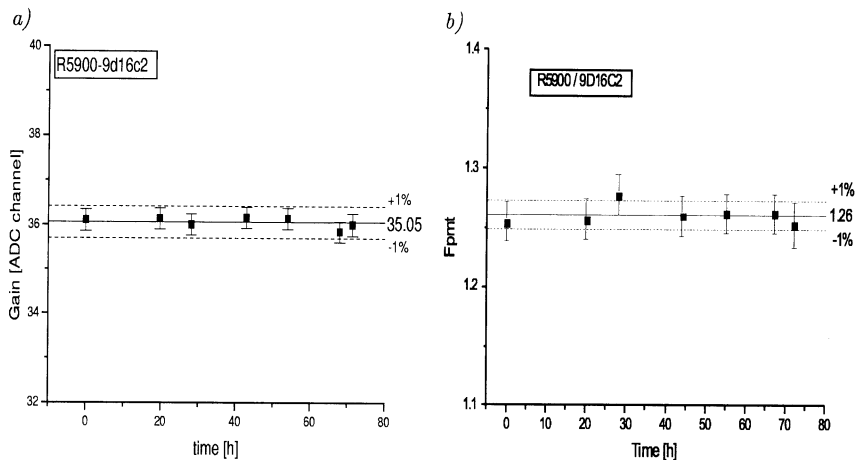

Fig. 6. The time stability of the PMT R5900/9d16c2 : *a*) the PMT gain (Q_1) vs time [hours], *b*) the excess factor vs time (hours); the used light source intensity applied was ≈ 2 photoelectrons.

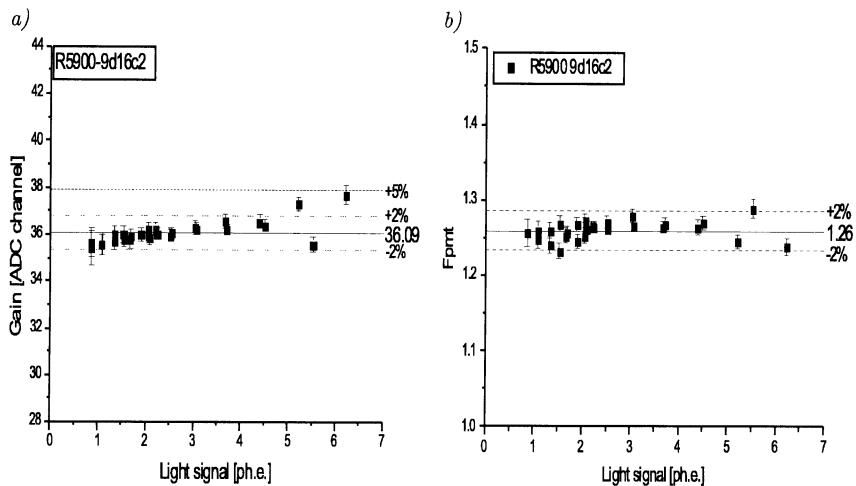

Fig. 7. Stability of retrieving of deconvoluted parameters: *a*) dependence of the PMT gain (Q_1) on light source amplitude, *b*) dependence of the excess factor on light source amplitude.

The method can be used as a calibration and monitoring tool for studying stability in time of a photomultiplier using the gain (parameter Q_1).

5 Acknowledgements

The authors want to thank the ATLAS/TILECAL collaboration for providing us with an R5900 photomultiplier as well as M. Pikna and P. Strmen (both Comenius Univ., Bratislava) for valuable remarks and technical help.

References

- [1] E. H. Bellamy et al., Nucl Instrum Meth A339,468-476(1994)
- [2] S. Tokar et al., Acta Physica Univ. Comeniana, Vol. XL(1999) 105-122
- [3] R. Dossi et al., INFN/TC-98/18,17 Luglio 1998,Frascati.
- [4] Method for Precise Analysis of the Metal Package Photomultiplier Single Photoelectron Spectra. By: I. Chirikov-Zorin,I. Fedorko, A. Menzione, I. Sykora and S. Tokar, Accepted to Nul. Instr. and Meth. A
- [5] S. Tokar et al., ATL-TILECAL-99-005,16 Feb 1999, CERN
- [6] Y. Yoshizawa, J.Takeuchi, Nucl Instrum Meth A387 (1997) 33
- [7] ATLAS Collaboration, ATLAS Technical Proposal for a General-Purpose pp experiment at the Large Hadron Collider, CERN/LHCC/ 94-93, CERN, Geneva, Switzerland.
ATLAS Collaboration, ATLAS TILE Calorimeter Technical Design Report, CERN/LHCC/96-42, ATLAS TDR 3, 1996,CERN, Geneva, Switzerland.
- [8] I. Fedorko, S.Tokar and I. Chirikov-Zorin, ATL-TILECAL-99-012, 19 May 1999, CERN
- [9] Bouhemaid,N et al., ATL-TILECAL-97-108, 28 Apr 1997, CERN
- [10] G. Barbiellini, A.Martins, F.Scuro, Nucl Instrum Meth., A362(1996)245

Received by Publishing Department
on May 31, 2000.

Чириков-Зорин И.Е. и др.

E13-2000-128

Прецизионный анализ одноэлектронных спектров
фотоумножителя в металлическом корпусе

Метод развертывания, основанный на усложненной функции отклика фотоумножителя, был использован для анализа одноэлектронных спектров фотоумножителя в металлическом корпусе. Анализировались спектры фотоумножителей R5600 и R5900 (Hamamatsu).

Детальный анализ показал, что метод достоверно описывает процесс умножения заряда в этих фотоумножителях в широкой области рабочих режимов, а развернутые параметры определяются с точностью до 1 %.

Метод может быть использован для детального анализа шумов фотоумножителя и с целью калибровки.

Работа выполнена в Лаборатории ядерных проблем им. В.П.Джелепова ОИЯИ и в Университете им. Коменского, Братислава, Словакия.

Препринт Объединенного института ядерных исследований. Дубна, 2000

Chirikov-Zorin I.E. et al.

E13-2000-128

Precise Analysis of the Metal Package Photomultiplier Single
Photoelectron Spectra

A deconvolution method based on a sophisticated photomultiplier response function was used to analyse the compact metal package photomultiplier spectra taken in single photoelectron mode. The spectra taken by Hamamatsu R5600 and R5900 photomultipliers have been analysed. The detailed analysis shows that the method appropriately describes the process of charge multiplication in these photomultipliers in a wide range of working regimes and the deconvoluted parameters are established with about 1 % accuracy. The method can be used for a detailed analysis of photomultiplier noise and for calibration purposes.

The investigation has been performed at the Dzhelepov Laboratory of Nuclear Problems, JINR and at the Comenius University, Bratislava, Slovakia.

Preprint of the Joint Institute for Nuclear Research. Dubna, 2000

Макет Т.Е.Попеко

Подписано в печать 14.06.2000
Формат 60 × 90/16. Офсетная печать. Уч.-изд. листов 1,43
Тираж 315. Заказ 52077. Цена 1 р. 70 к.

Издательский отдел Объединенного института ядерных исследований
Дубна Московской области